

FLUORESCENT



300 Series *Rust Resistant Vandal-Resistant Wall/Ceiling Luminaire* 32 Watts Maximum

Designed for indoor/outdoor uses where efficiency and style must compete with abuse by environmental elements or vandalism. **Rust resistant.** Engineered with components and materials offering **high resistance to corrosion and impact.** The **polycarbonate** housing is **nonconductive**, assuring more safety to the end user. A wide selection of colors and options adds to the versatility of this luminaire. Ideally suited as security lighting for homes, schools, motels, hospitals, condominiums and industrial, commercial and government buildings.

Specifications

Lens:	Injection molded of UV-stabilized polycarbonate . Average thickness is 1/8". Smooth exterior surface for ease of cleaning. Selections include Clear Prismatic, Opal White, Buglight Yellow, Amber, Green, Blue (law enforcement use only) and single-end trim finish in black, white, or bronze on Clear Prismatic or Opal White.
Base Plate:	Rust resistant .080" 5052 H-32 tempered marine-grade aluminum.
Housing: (optional)	Injection molded in black, white, or bronze UV-stabilized, reinforced polycarbonate . Rear knockout for supply wire. Available with up to four threaded connections and plugs suitable for 1/2" conduit. PLT models include 3H housing.
Gasket:	Closed-cell neoprene rubber in 1/8" thickness creates a tight seal against contaminants and moisture.
Socket:	Two-pin and four-pin type with leads insulated for 105°C.
Lamp: (optional)	High efficiency PL twin tube, quad tube and PLT lamps offer up to ten times longer life and 70% energy savings over comparable incandescent lamps. PLT 0°F minimum starting temperature.
Ballast:	Self-start preheat type in Normal Power Factor (NPF)120V or High Power Factor (HPF)120V-277V. Electronic ballast standard with PLT, 0°F start temperature.
Hardware:	Four stainless steel 8-32 phillips truss head screws or tamperproof screws attach lens to base plate. Mounting hardware included.
Mounting:	Ceiling. Wall vertically with lamp base up.

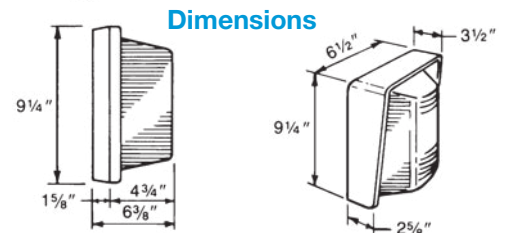
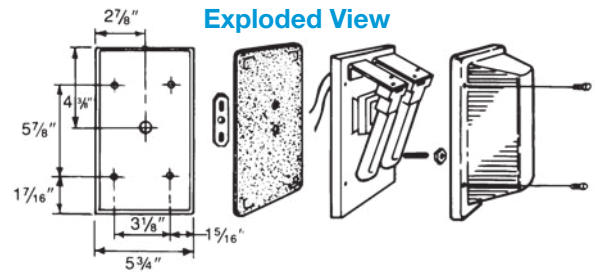

With Optional Housing

With Optional Decor Pack



Shown With 300-S Lens and Optional Housing

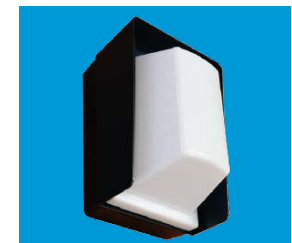

Shown With Optional Decor Pack



**SBA QUALIFIED
SMALL BUSINESS MANUFACTURER**

TAA COMPLIANT
TRADE AGREEMENT ACT COMPLIANT

ETL-US and ETL-C Listed for Wet Location

All polycarbonate components meet Underwriters Laboratories 746C tests for polymeric material and carry a flammability rating of 94HB or better on lenses and the superior 94-5V rating on housings.

Luminaire Type _____
 Catalog Number _____
 Job Name _____
 Approval _____

WF Harris Lighting, Inc.™

Innovative Lighting Designs Since 1970
 P.O. Box 5023, Monroe, NC 28111-5023, USA
 704.283.7477 (HEADQUARTERS) • 800.842.9345 (TOLL FREE)
 e-mail: customerservice@wfharris.com
 www.wfharrislighting.com

Form 1553 5/19

"A Live Operator Company Standing Ready to Serve Your Lighting Needs"

FLUORESCENT

Ordering Information (Fill In Blanks For Complete Catalog Number)

Model	Lens Color	Painted Lens Color	Housing Color	Watts-Lamp	Power Factor	Volts	Options	Conduit Connections
300	CP -Clear Prismatic	HK -Black		7 PL ⁸	NPF	120	LP -Lamp	CRS -Right Side ⁶
300-S ⁴	OW -Opal White ³	HW -White		9 PL ⁸	HPF	120-277	PC -Photo Control (Specify 120 or 277)	CLS -Left Side ⁶
	BY -Buglight Yellow	HB -Bronze		13 QD (2-pin) ⁵			3H __-Housing (Specify Color)	CT -Top ⁶
	A -Amber	(Note: Lens Color Based on Housing Color)		13 QD (4-pin) ^{1,5}			K -Black W -White B -Bronze	CB -Bottom ⁶
	G -Green			2-7 PL ⁸			DP __-Decor Pack (Polycarbonate)	C4 -All Four Sides ⁶
				2-9 PL ⁸			(Specify Color) K -Black W -White B -Bronze	
				18 PLT * ^{1,5}			GCO -Grounded Convenience Outlet ^{2,7}	
				26 PLT * ^{1,5}			SW/B -On/Off Switch with Boot ^{2,7}	
				32 PLT * ^{1,5}			FS -Fuse and Holder	

Accessories (Order Separately)

TPT-Tamperproof Screwdriver 

¹Housing included

²Dry locations only

³For 300-S Opal White painted lens, consult factory for availability and pricing

⁴Specify painted lens color on Clear Prismatic
BK-Black **WH**-White **BZ**-Bronze

⁵Only available in HPF 120-277V

⁶Positions based on facing luminaire

⁷Housing required

⁸Only available in NPF 120V

* Electronic ballast 0°F self-start

Light Distribution Patterns

Model 300-CP-2-9 PL
Wall Mounted 6' M.H.
Test Report No. 30778

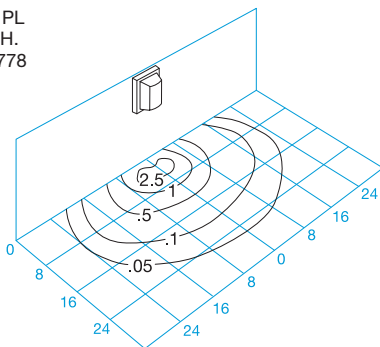

Conversion Tables

Lamp	Lamp Conversion Factor(LCF)	Wall Mounting Height	Height Conversion Factor(HCF)	Ceiling Mounting Height	Height Conversion Factor(HCF)
2-9 PL	1.00	6'	1.00	7'	1.77
13 QD	.72	7'	.73	8'	1.00
2-7 PL	.67	8'	.56	9'	.79
9 PL	.50	9'	.44	10'	.64
7 PL	.33	10'	.36		
18 PLT	1.00				
26 PLT	1.50				
32 PLT	2.00				

Using Conversion Tables

TO ADJUST FOOTCANDLES (FC) SHOWN IN DIAGRAMS AT LEFT, USE FOLLOWING FORMULAS WITH LAMP CONVERSION FACTOR (LCF) AND HEIGHT CONVERSION FACTOR (HCF):

$$FC \times LCF = FC \text{ with alternate lamp}$$

$$FC \times HCF = FC \text{ at alternate height}$$

$$FC \times LCF \times HCF = FC \text{ with alternate lamp at alternate height}$$

Fluorescent Lamp Performance

	7 Watt Twin	9 Watt Twin	13 Watt Quad (2 pin)	13 Watt Quad (4 pin)	2-7 Watt Twin	2-9 Watt Twin	18 Watt PLT	26 Watt PLT	32 Watt PLT
Input Watts	11W	11W	17W	13W	22W	22W	18W	26W	32W
Lumen Output	400	600	860	900	800	1,200	1,200	1,800	2,400
Lamp Life (Hours)	10,000	10,000	10,000	10,000	10,000	10,000	16,000	16,000	16,000
Min. Starting Temp	0°F	25°F	32°F	0°F	0°F	25°F	0°F	0°F	0°F

Specifications Subject to Change Without Notice

Fixture is Warranted to be Free of Defects in Materials and Workmanship for One Year From Invoice Date.



**SBA QUALIFIED
SMALL BUSINESS MANUFACTURER**

TAA COMPLIANT
TRADE AGREEMENT ACT COMPLIANT

W.F. Harris Lighting, Inc.™

Innovative Lighting Designs Since 1970

P.O. Box 5023, Monroe, NC 28111-5023, USA

704.283.7477 (HEADQUARTERS) • 800.842.9345 (TOLL FREE)

e-mail: customerservice@wfarris.com

www.wfharrislighting.com

Printed in USA

Form 1553

5/19

"W. F. Harris Lighting Will Not Sacrifice Quality for the Sake of Price."